

LiMONE - avrundet Design Speil m/ sandblåst ramme



LiMONE - avrundet og myk i sitt design!

Speil m/ sandblåst kant har akryl bakramme, slik at det også gir et fint lys ut på sidene rundt speile. LED-lys. LiMONE kommer med innebygget Bluetooth og høyttaler.

Nå kan du enkelt koble deg til for å **spille musikk** eller **radio** fra din mobil!

Den har vår unike sensor hvor du slår av/på, dimmer lyset og justerer fargen fra varmt til kaldt lys. Og alt dette kun gjennom 1 sensor.



Bluetooth®



LiMONE Speil Mål: B: 60 – 90 – 120 cm

H: 70 cm og D: 3 cm

Før montering:

av **SPEIL**

- Monterings høyde på speil er individuelt ut fra type og hva man ønsker.
Men anbefalt høyde er 195 cm
 - * Disse speilene trenger ikke spikerslag.
Det holder med plugg og skrue
 - * Strømuttak midt bak der speile skal henge.
Og da helst i boks.

Måltegning – LIMONE 60

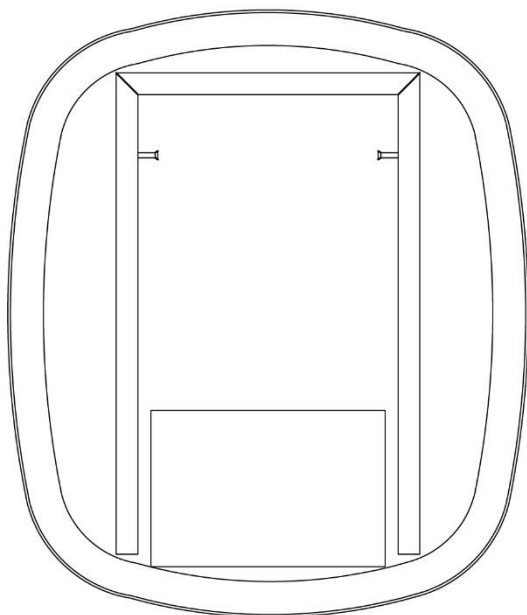
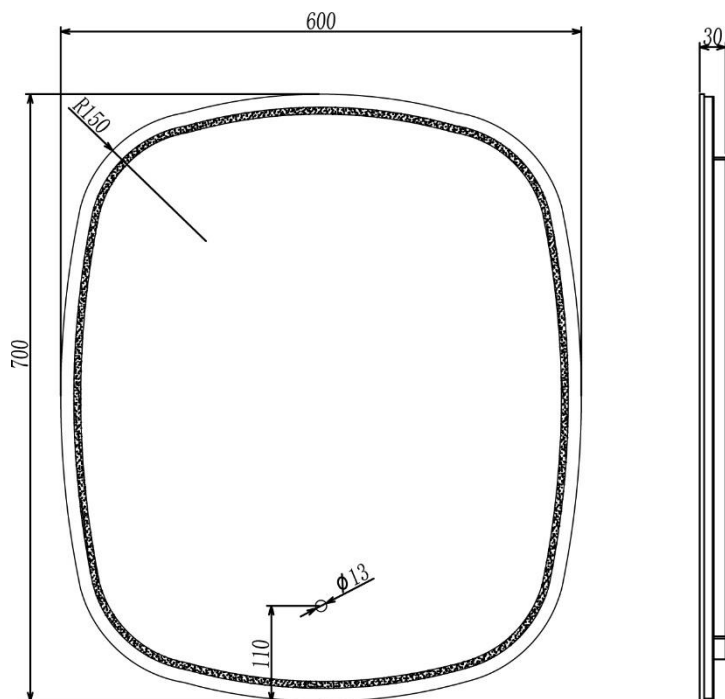

Måltegning – LIMONE 90

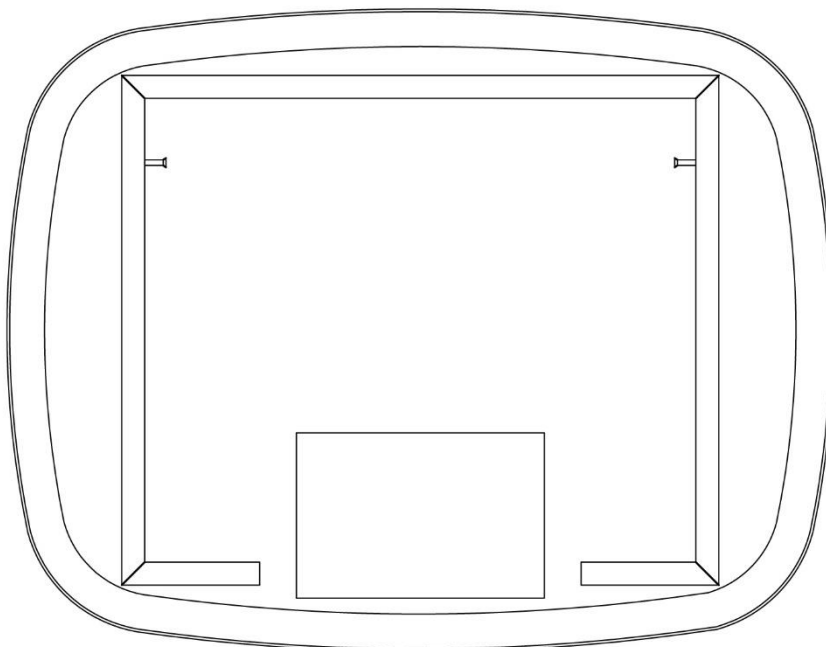
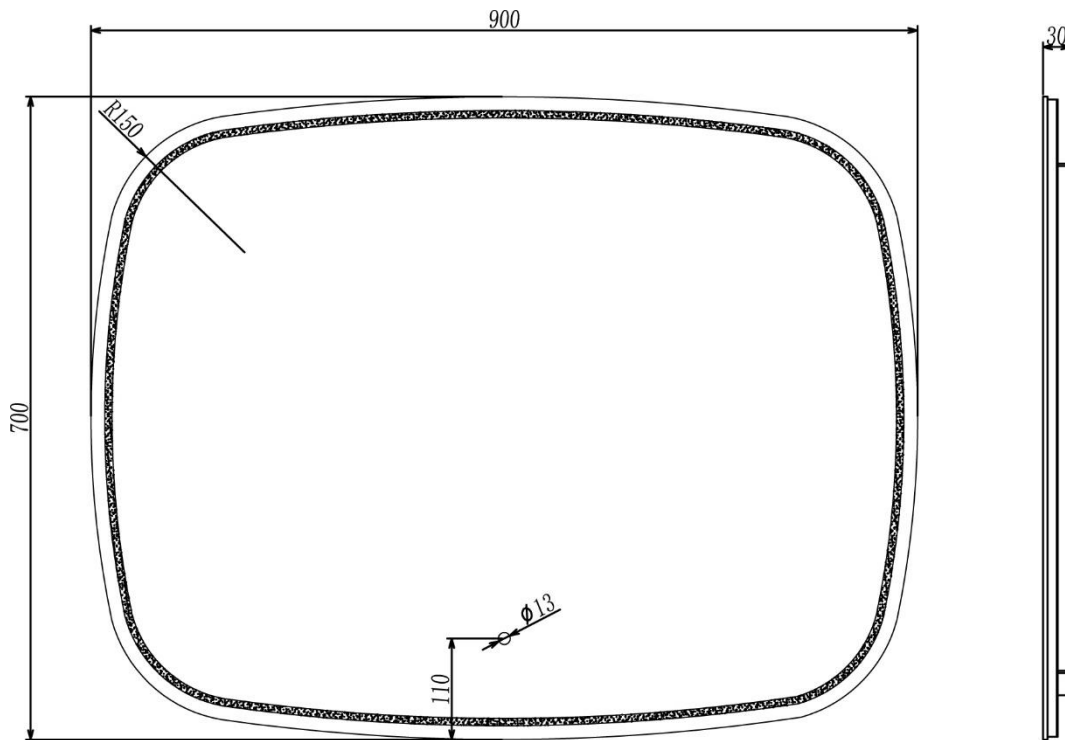

Måltegning – LIMONE 120

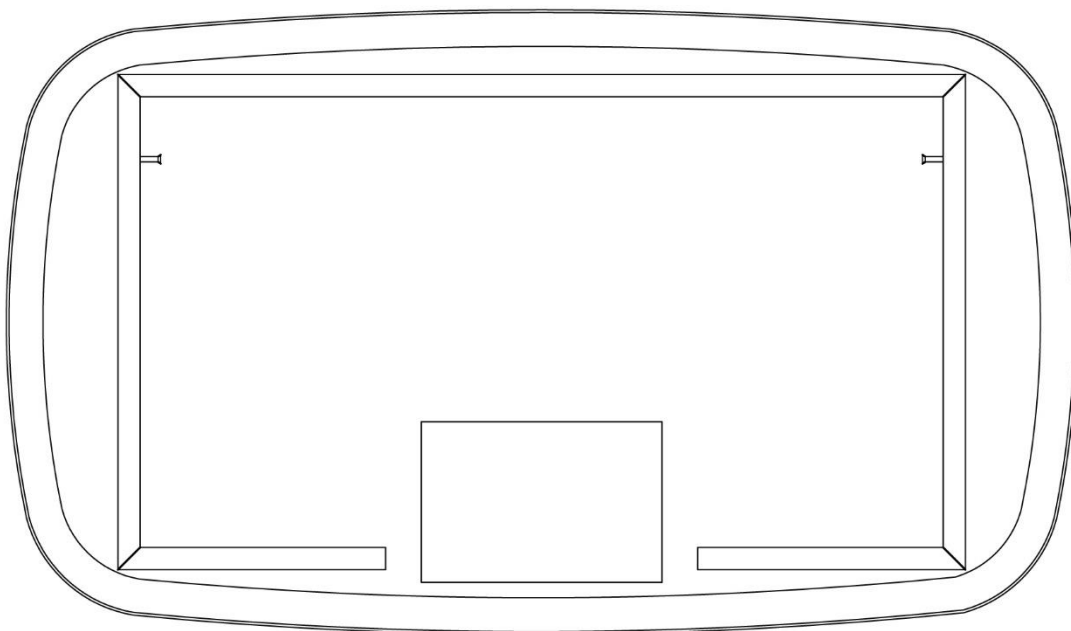
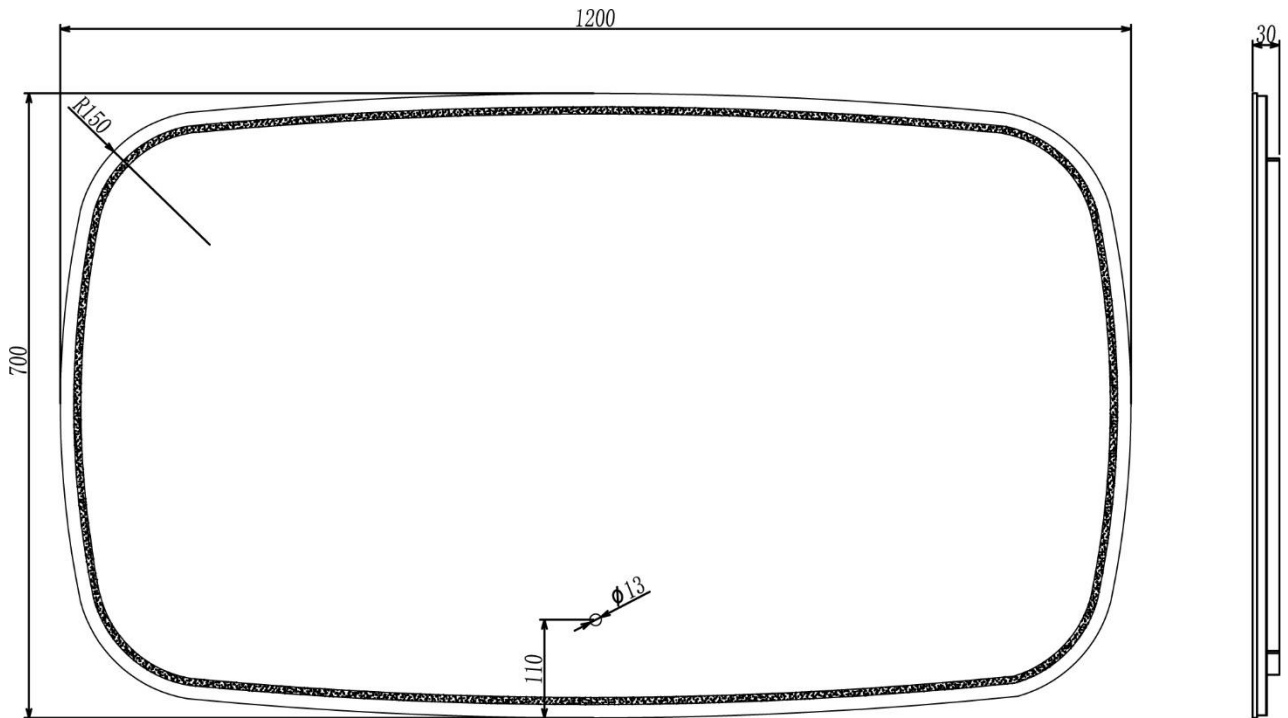

Installation & aftercare instructions

Please retain for future reference

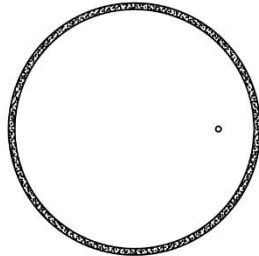
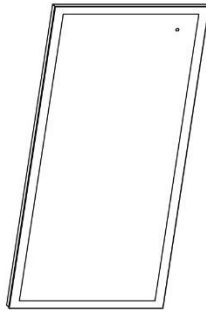
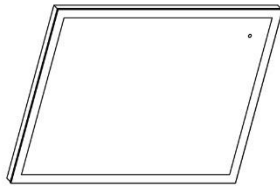

ELECTRICAL SAFETY INSTRUCTIONS

All fittings must be installed by a competent person, in accordance with current IEE wiring regulations. If in doubt consult a qualified electrician.

IMPORTANT

Always switch off the electrical supply at the mains during installation and maintenance. It is recommended that the fuse is withdrawn or the circuit breaker is switched off for the necessary circuit before installation commences.

Fitting in Bathrooms is subject to the appropriate zone in accordance with IEE Regulations. This product is suitable for zone 2 and outside zones. IT IS NOT suitable for installation in Zone 0 or Zone 1. It is also not suitable for installation in saunas, steam rooms or shower cubicles. This product is only suitable for permanent installation. DO NOT connect to a trailing plug and socket outlet. Although this product has an Ingress Protection rating of IP44 it is only suitable for indoor use. Do not attach the product to surfaces that are damp or otherwise electrically conductive.

INSTALLATION CARE & SAFETY

Wear suitable eye protection when drilling. Take care when using power tools near water - the use of a residual current device (RCD) is advised. Beware of hidden cables or pipes. Take care if drilling on tiled surfaces in case the drill slips. A piece of masking tape applied to the wall before marking out the fixing holes will stop the drill from wandering.

IMPORTANT

The product must be installed with a minimum distance of 150mm between the infrared sensor and an adjacent wall or obstruction to ensure correct function of the sensor (see diagram below).

DO NOT strike glass components with hard or pointed items. DO NOT place very hot or very cold items against or in close proximity to glass surfaces unless an adequately thick insulation material is used to prevent such items coming in contact with the glass.

The nominal thickness of the mirror glass used in this product is 5mm and is film backed for safety. If the glass becomes chipped or broken replace immediately.

This product should be positioned well away from curtains and other fabrics. Never cover the mirror. This product is heated, we recommend that it is turned off after use and should never be left on for prolonged periods of time.

This product could be dangerous and is only to be installed by a competent person.

CLEANING

It is recommended that the unit is cleaned with a soft, dry, non abrasive cloth when turned off. Never use cleaning agents or abrasive materials on any type of surface finish. Do not allow moisture to come into contact with the electrical components.

COMPLIANCE

This product complies with all relevant British and European safety standards:

WIRING

This product is manufactured to class I category and must have an earth connection.

COLOUR CODING:

L - Live = Brown
N - Neutral = Blue

LIGHTS

To obtain a replacement LED lamp if faulty or broken contact customer services (see details at foot of page) quoting product code.

Bathroom Zones Diagram

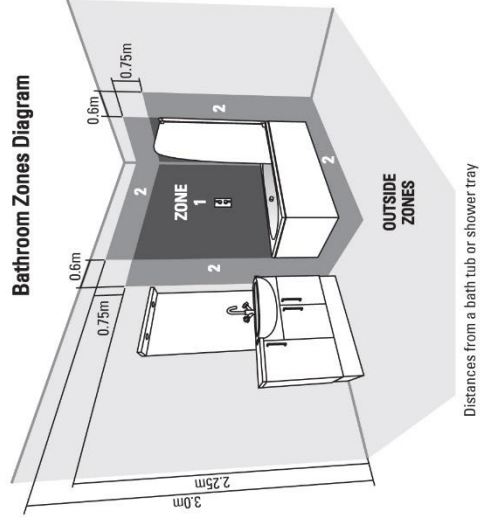

Installation & aftercare instructions

Please retain for future reference

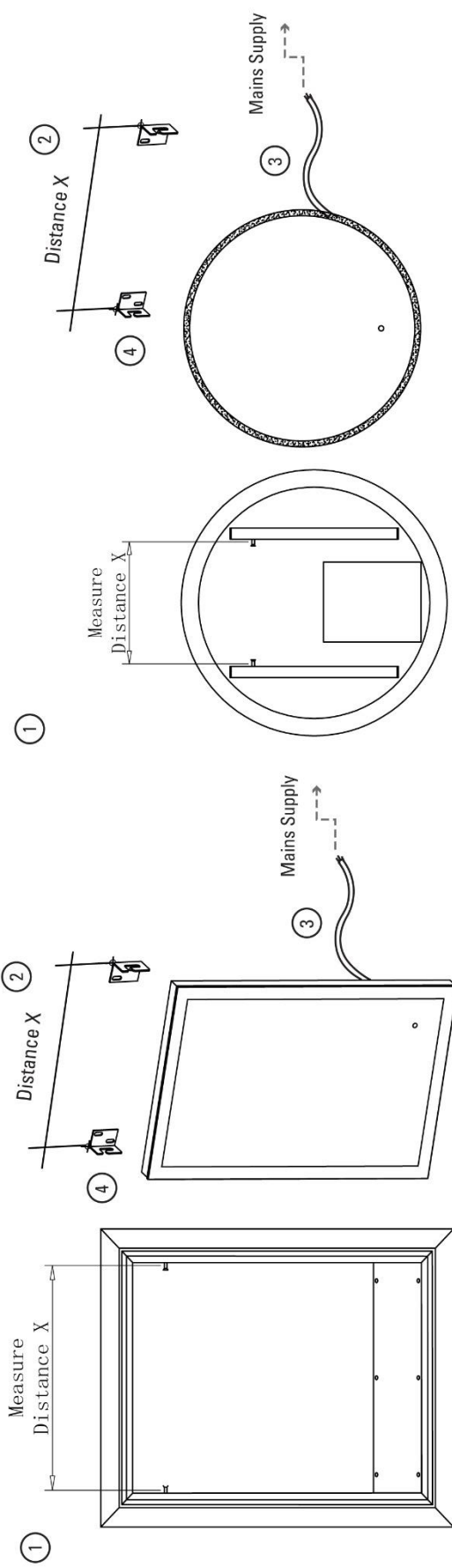

Portrait View

INSTALLATION PROCEDURE

The wall surface must be of suitable strength and construction.

- 1) Measure the distance (x) between the wall fixing pins on the back of the mirror. For horizontal mounting measure between the fixing pin and the keyhole slot.
- 2) For portrait mounting, mark out the wall mounting plates on the wall using a pencil to the desired height ensuring they are spaced at distance (x).
If mounting landscape mark out 1 wall mounting plate and mark out a single screw position using dimension (x) for the keyhole slot.
Drill the marked out positions and fit the wall plugs accordingly. Secure the wall mounting plates in position with the screws provided.

NOTE: The wall plugs supplied are only suitable for solid stone / brick walls. For plasterboard walls use specialist wall plugs.

- 3) The next step is to make the electrical connection from the mirror to the mains supply. Use the connection wire found at the rear of the mirror to make the necessary connections in accordance with the current IEE regulations. A second person will need to hold the mirror in place whilst electrical connections are made.

THIS PRODUCT IS MANUFACTURED TO CLASS I CATEGORY AND MUST HAVE AN EARTH CONNECTION.

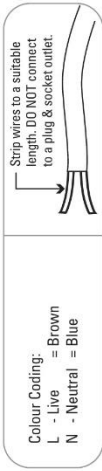

IF IN DOUBT CONSULT YOUR ELECTRICIAN

- 4) The mirror should slide onto the wall mounting brackets and secure into place. For a landscape installation, the keyhole slot should be positioned on a single screw first before sliding onto the wall bracket for ease of installation.

To remove the mirror, the mirror should first be lifted and then pulled away from the wall.

OPERATING INSTRUCTIONS

Lighting is turned on / off by waving a hand past the IR sensor on the mirror glass, which is positioned in the bottom right when hung portrait and bottom left when hung landscape. DO NOT leave on for prolonged periods of time.

Installation Manual

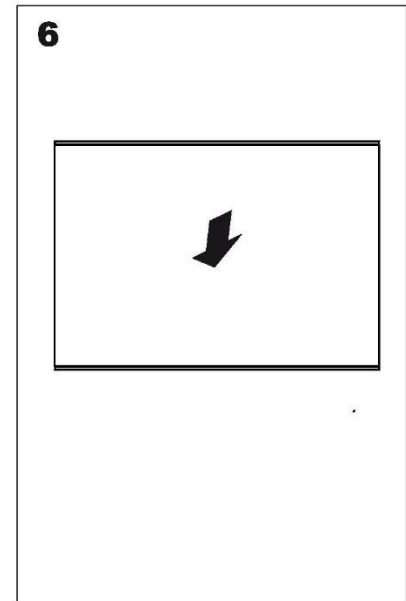
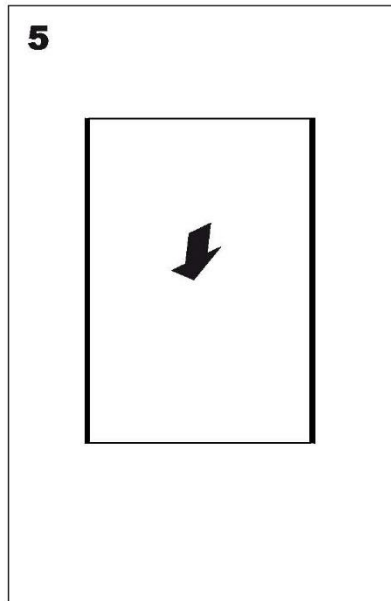
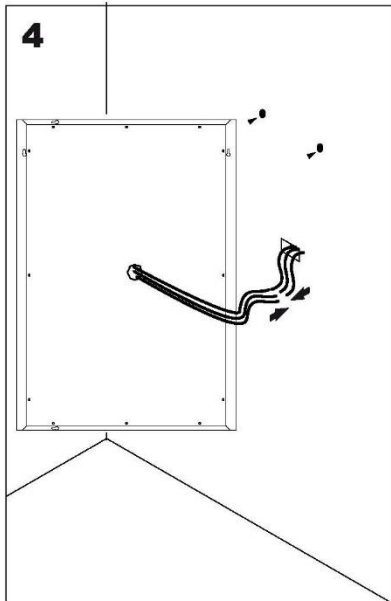
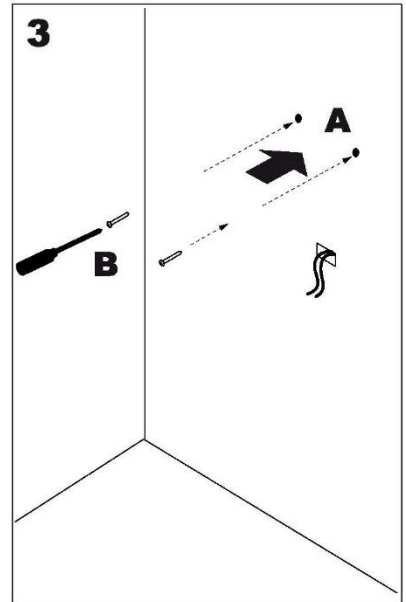
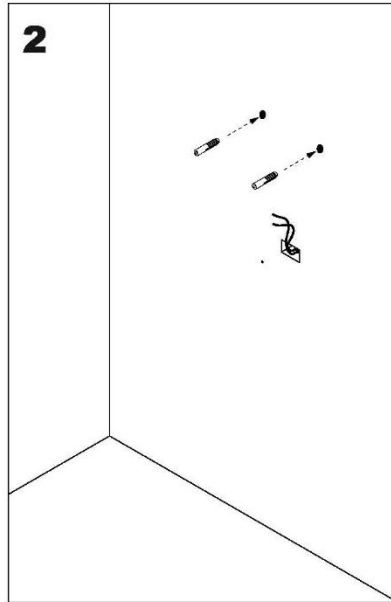
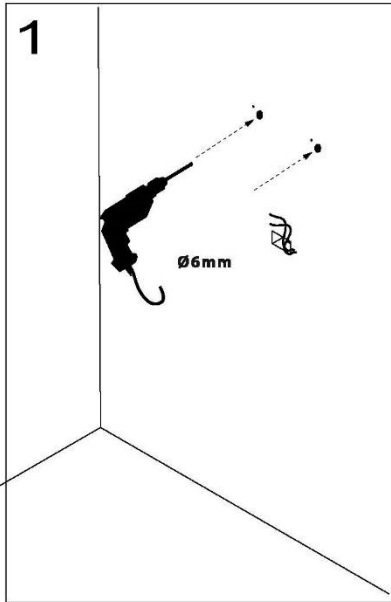

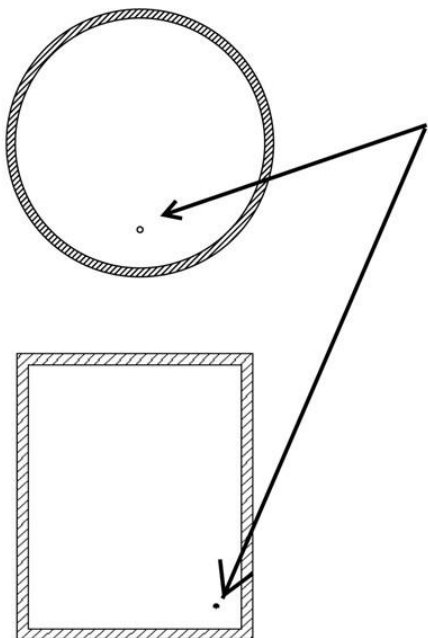

JUSTERING av LED-lyset

- For å slå **PÅ** eller **AV** Led-lyset, før hånden forbi IR sensoren

DIMMING

- Hold hånden foran IR sensoren, når lyset er **PÅ**, inntil dimeren er aktivert og lyset justeres ned. Ta hånden bort. Så foran IR sensor igjen, for å justere opp lysstyrken igjen.

FARGE JUSTERING av lys fra **VARMT** til **KALDT**

- Slå **AV** Led-lyset, for så å holde hånden foran IR sensoren. Lyset i speilen vil nå justere seg fra varmt til Kaldt lys.
- Start på nytt ved å føre hånden forbi IR sensoren igjen etter ferdig justert lysstyrke og lysfarge

Vedlikehold og Rengjøring av **Speil / Speilskap**

Bruk vaskemidler som er beregnet på Glass til Speilflatene.
Og gjerne en Mikrofiber klut.
Innvendig i Speilskap brukes rene, milde vaskemidler.
Tørk av med myk klut for å fjerne vannrester.

Samsvarserklæring:

Leverandør: **Scala Bad AS**
Vekstveien 5A – Røyken Næringspark
3474 ÅROS

Produkt: **LIMONE**

Rating: LIMONE - Bredde: 60 + 90 + 120 cm
220 – 240 V, 50/60 Hz;

Scala Bad AS bekrefter at produktene ovenfor er testet og funnet i samsvar med følgende teststandard:

Standard: EN 60598-2-1:1989
EN 60598-1:2015+A1: 2018
EN 62493:2015
IP44
CE